







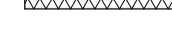
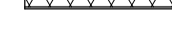

Renvooi

-  metal studwand
-  binnenwand
-  isolatie
-  houtskeletbouw binnenblad
-  betonnen constructie elementen

 entreepijl

baksteen metselwerk:

-  baksteen metselwerk type A
-  baksteen metselwerk type B
-  baksteen metselwerk v.v. keimwerk

Type A
bnr. 01
(H2/P91/B181)

- Bnr. = bouwnummer
- H = huisnummer
- P = parkeerplaatsnummer
- B = bergingnummer

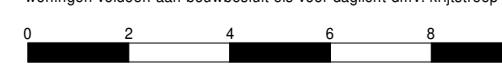
woningen voldoen aan bouwbesluit eis voor daglicht dmv. krijtstreep methode
 schaal 1 : 150

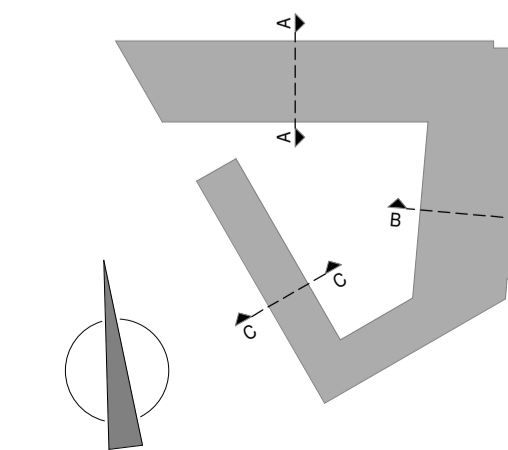

Project
De Cascade
Onderwerp
Overzichtsplattegrond
derde verdieping
Datum
15-05-2020

VK.103

Schaal
1:150
Formaat
A1